

Lantech

I(P)GS-0208C

**8 10/100/1000T + 2 10/100/1000T/ Dual
speed SFP combo (8 PoE at/af) Industrial
Unmanaged Switch**

User Manual

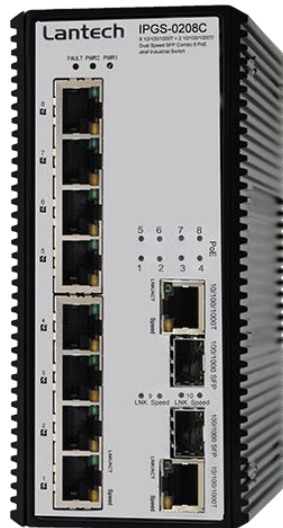

V1.02
NOV. 2024
RP-001-31

Approval Information

Version 1.02	Name	Title	Date
Author	Greg Tsai	Marketing	2024.11.27
Verifier	Jacky Chou	HW QA	2024.11.27
Approver	Thomas Lee	RD head	2024.11.27

Version	Date	Content of Modification	Author(s)
V1.00	2023.10.16		Greg Tsai
V1.01	2024.11.19	Update the spec of PoE budget.	Greg Tsai
V1.02	2024.11.27	Update the DIN Rail installation guide	Greg Tsai

Recommendation for Shielded network cables

STP cables have additional shielding material that is used to reduce external interference. The shield also reduces the emission at any point in the path of the cable. Our recommendation is to deploy an STP network cable in demanding electrical environments. Examples of demanding indoor environments are where the network cable is located in parallel with electrical mains supply cables or where large inductive loads such as motors or contactors are in close vicinity to the camera or its cable. It is also mandatory to use an STP cable where the power device (like IP camera) is used outdoors or where the network cable is routed outdoors.

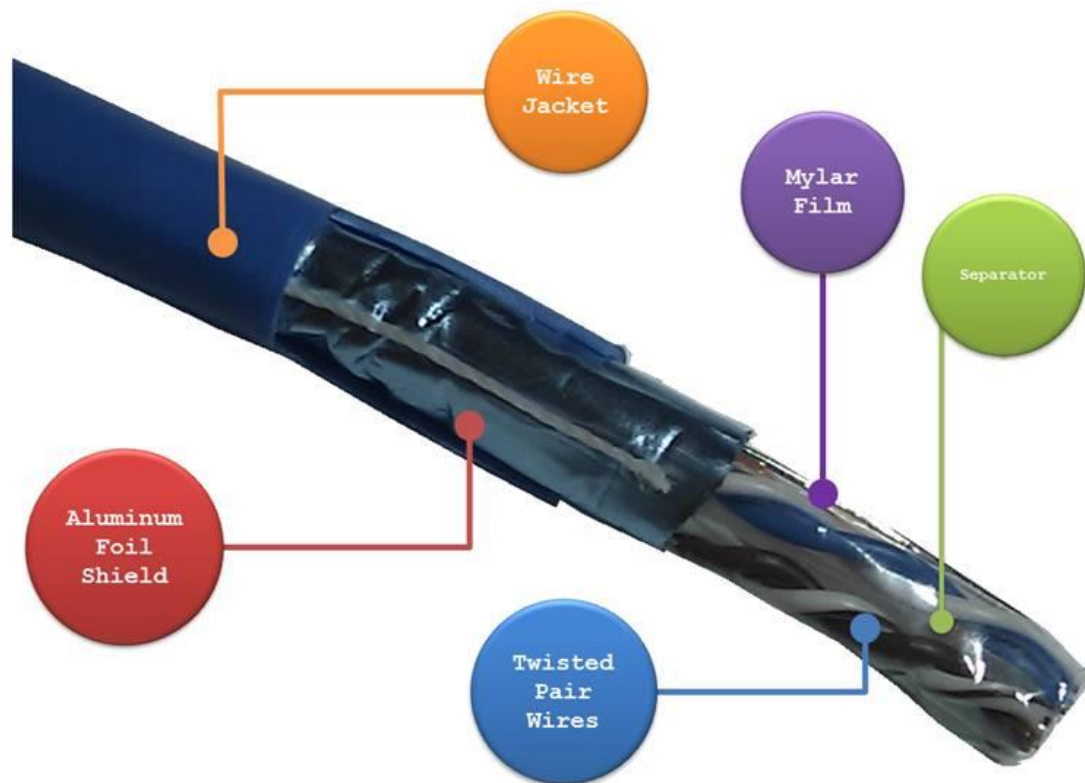

Content

Overview	3
Introduction	3
Packing List.....	3
Safety Precaution.....	3
Hardware Description.....	4
Front Panel.....	5
Top View	6
Dimensions	7
Wiring the Power Inputs	8
LED Indicators.....	10
RJ-45 Pin Assignments.....	11
Cabling	13
Mounting Installation	17
DIN-Rail Mounting.....	17
Wall-Mount Plate Mounting	19
Hardware Installation	21
Installation Steps.....	22

Troubleshooting	23
-----------------------	----

Overview

Introduction

Lantech I(P)GS-0208C is a high performance all Gigabit switch with 8 10/100/1000T + 2 10/100/1000T/ Dual speed SFP combo (8 PoE at/af)

For latest product specifications, please refer to [Lantech official site](#).

Packing List

- 1 x Industrial Ethernet Switch
- 1 x Terminal Block
- 1 x Quick Installation Guide

Safety Precaution

Attention If DC voltage is supplied by an external circuit, please use a protection device on the power supply input.

Hardware Description

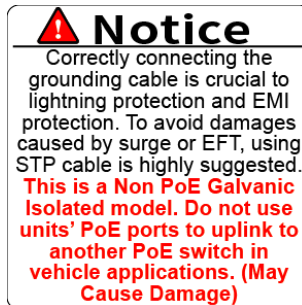

For POE models: Do not use units' POE ports to uplink to another POE switch in vehicle applications. (May Cause Damage) Lantech strongly advise the installation of a Galvanic isolated DC/DC converter between the power supply and the Ethernet switch on all Non-Isolated models. Please contact the sales team for advice on which models support isolated power design.

Alert! PoE Budget for Unmanaged POE Switch Model

Each PoE switch model has its own PoE budget limit, which will supply PoE power according to the port sequence and devices' PoE classification. On an unmanaged PoE switch, power distribution is based on the device's class level, determined through a handshaking process per port. The switch will deduct the used budget for each connected device, leaving the remaining budget for subsequent devices based on their class negotiation, rather than distributing a fixed 15W per port.

To avoid issues, calculate the PoE consumption of all connected devices beforehand. If the total PoE requirement exceeds the budget, the switch may shut down and attempt to reboot. If the PoE demand remains over budget after rebooting, the switch will continue to experience power failures.

Note *The SFP/Copper Combo port can't both work at the same time. The SFP port has the higher priority than copper port; if you insert the **1000M SFP** transceiver (which has connected to the remote device via fiber cable) into the SFP port, the connection of the accompanying copper port will link down.*

*If you insert the **1000M SFP** transceiver into the SFP port*

even without a fiber connection to the remote, the connection of the accompanying copper port will link down immediately.

Note *Using **100M SFP** modules on this unmanaged switch may lead to SFP compatibility issues. Users are advised to verify compatibility in advance.*

In this paragraph, we will introduce the Industrial switch's dimensions, port, cabling information, and wiring installation.

Front Panel

The Front Panel of the switch is shown as below.

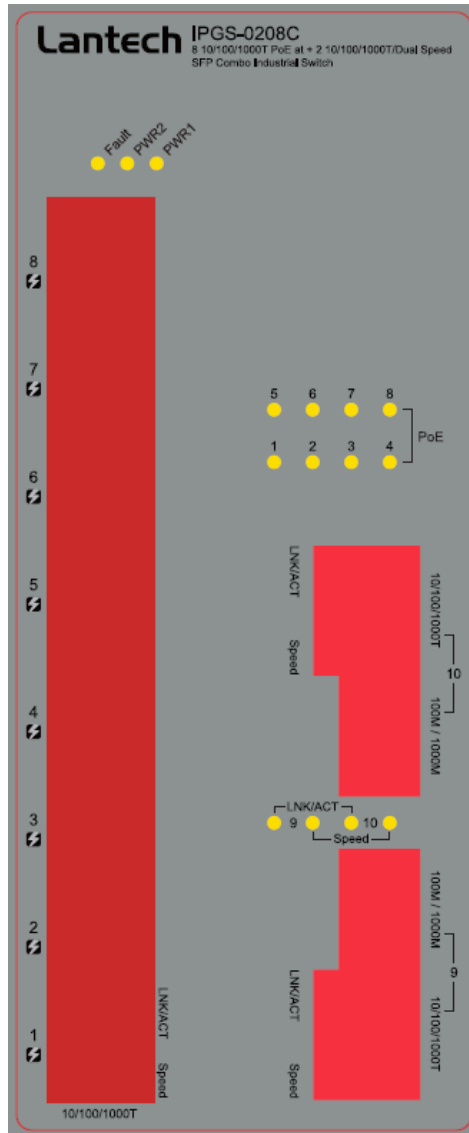

Front Panel of the Industrial Switch
 (The PoE LED is only available on PoE models)

Top View

The top panel of the Industrial Switch is equipped one terminal block connector of two DC power inputs.

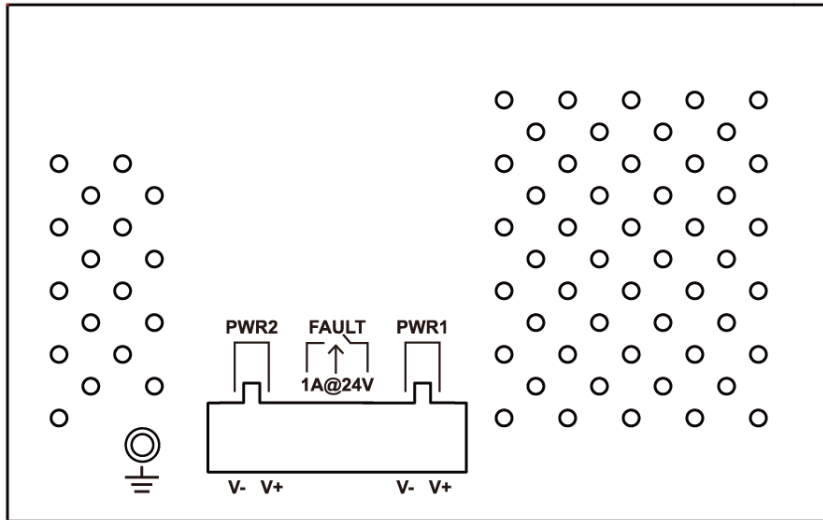

Top panel of the Industrial Switch Converter

Dimensions

. The dimensions are 74 x 152 x 105 mm (W x H x D). The figure below gives the dimensions and views of each side of the Industrial Switch.

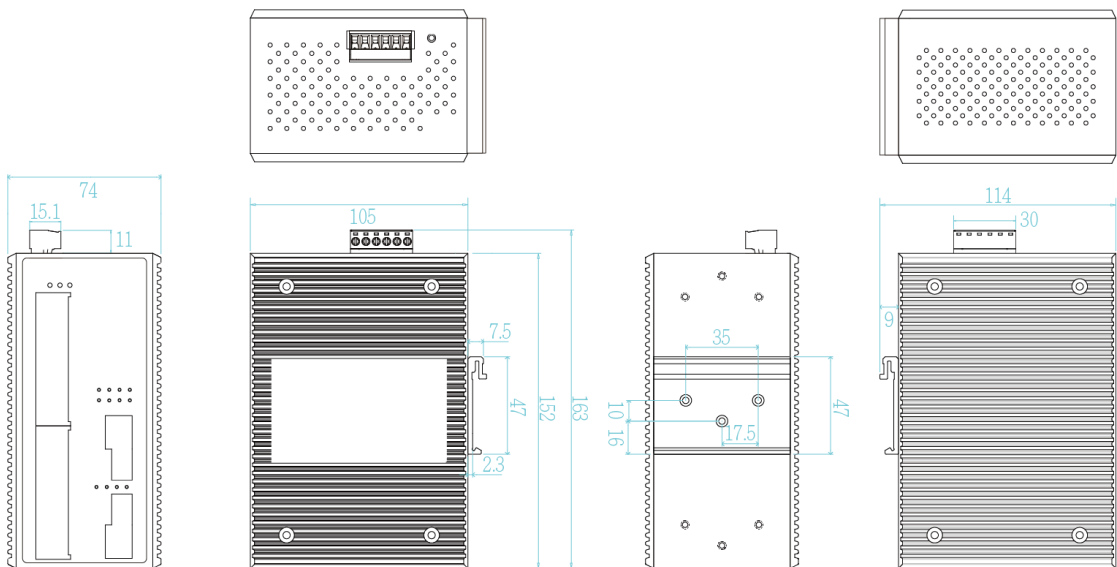

Wiring the Power Inputs

■ Voltage of Power Input

IPGS-0208C-12V	12V model: The power input voltage can be from 9.5V to 56VDC to feed power on both the 802.3af and 802.3at standardized devices.
IPGS-0208C-24V	24V model: The power input voltage can be from 9V to 36VDC to feed power on both the 802.3af and 802.3at standardized devices.
IPGS-0208C-48V	48V model: The power input voltage can be from 45V to 56VDC to feed power on both 802.3af/at standardized devices.
IGS-0208C-12V	12V model: The power input voltage can be from 9.5V to 60VDC
IGS-0208C-24V	24V model: The power input voltage can be from 9V to 36VDC

Please make sure that the external power supply unit you use to provide the PoE voltage meet the following criteria: The power consumption can satisfy the total power request from all PD devices required.

Please follow the steps below to insert the power wire.

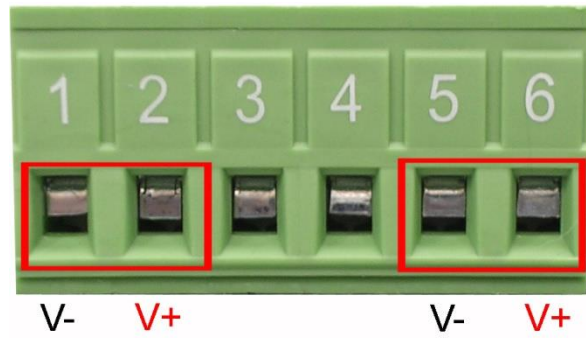

1. Insert the positive and negative wires into the V+ and V- contacts on the terminal block connector.

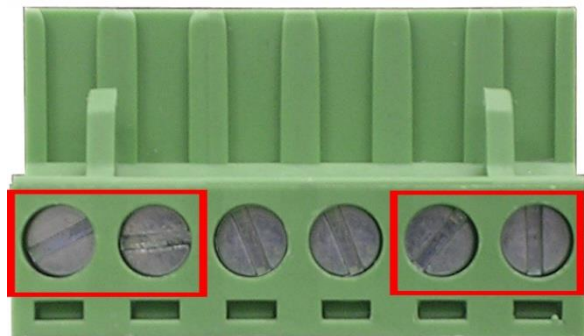

2. To tighten the wire-clamp screws for preventing the DC wires to loose.

Note *The wire gauge for the terminal block should be in the range between 12~ 24 AWG.
50-57VDC input is recommended for 802.3at 30W applications.*

LED Indicators

The LED indicators located on the front panel display the power status and network status of the Industrial switch; each has their own specific meaning as the table shown below.

LED	Color	Description	
P1	Green	On	Power input 1 is active
		Off	Power input 1 is inactive
P2	Green	On	Power input 2 is active
		Off	Power input 2 is inactive
Fault	Red	On	Power input 1 or 2 is inactive
		Off	Power input 1 and 2 are both functional, or no power inputs
1 ~ 8 LNK/ACT (Upper LED)	Green	On	Connected to network
		Flashing	Networking is active
		Off	Not connected to network
1 ~ 8 Speed (Lower LED)	Yellow	On	Connected to network at speed of 1000Mbps
		Off	Not connected to network or not working at speed of 1000Mbps
9 ~ 10 LNK/ACT	Green	On	A network device is detected.
		Blinking	The port is transmitting or receiving packets from the TX device.
9 ~ 10 Speed	Yellow	On	Connected to network at speed of 1000Mbps
		Off	Not connected to network or not working at speed of 1000Mbps
PoE (IPGC only)	Green	On	Link to PD(PoE device)
		Off	Link to none PoE device

RJ-45 Pin Assignments

The UTP/STP ports will automatically sense for Fast Ethernet (10Base-T/100Base-TX) or Gigabit Ethernet (10Base-T/100Base-TX/1000Base-T) connection. Auto MDI/MDIX means that the switch can connect to another switch or workstation without changing straight through or crossover cabling. See the figures below for straight through and crossover cable schema.

■ 10/100Base-TX Pinouts

Pin Number	Assignment
1	Tx+
2	Tx-
3	Rx+
6	Rx-

Note “+” and “-” signs represent the polarity of the wires that make up each wire pair.

The table below shows the 10Base-T/100Base-TX MDI and MDI-X port pinouts.

Pin Number	MDI-X Signal Name	MDI Signal Name
1	Receive Data plus (RD+)	Transmit Data plus (TD+)
2	Receive Data minus (RD-)	Transmit Data minus (TD-)
3	Transmit Data plus (TD+)	Receive Data plus (RD+)
6	Transmit Data minus (TD-)	Receive Data minus (RD-)

■ **10/100Base-TX Cable Schema**

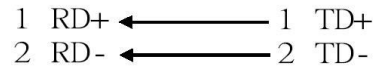
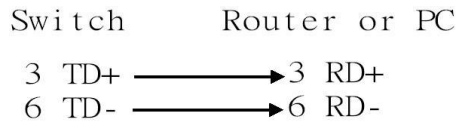

Straight Through Cable Schema

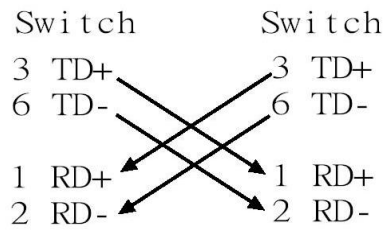

Crossover Cable Schema

■ **10/100/1000Base-T Pinouts**

The table below describes the gigabit Ethernet RJ-45 pinouts.

Pin	Signal name	Description
1	BI_DA+	Bi-directional pair A+
2	BI_DA-	Bi-directional pair A-
3	BI_DB+	Bi-directional pair B+
4	BI_DC+	Bi-directional pair C+
5	BI_DC-	Bi-directional pair C-
6	BI_DB-	Bi-directional pair B-
7	BI_DD+	Bi-directional pair D+
8	BI_DD-	Bi-directional pair D-

- **10/100/1000Base-T Cable Schema**

The following two figures illustrate the 10/100/1000Base-T cable schema.

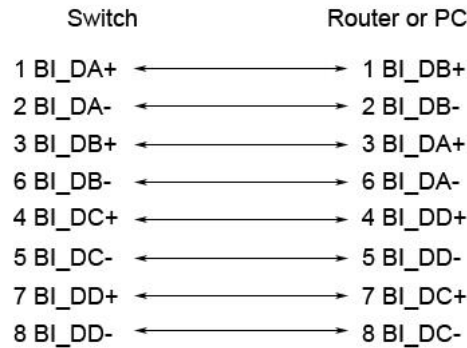

Straight Through Cable Schema

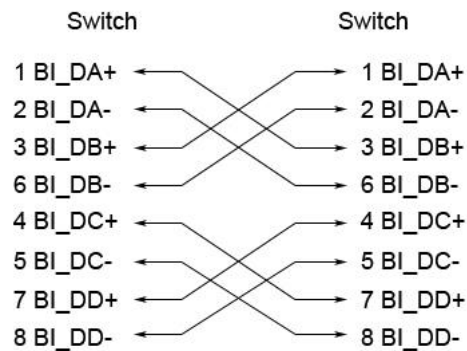

Crossover Cable Schema

Cabling

- Use unshielded twisted-pair (UTP) or shielded twisted-pair (STP) cable for RJ-45 connections: 100Ω Category 3, 4 or 5 cable for 10Mbps connections, 100Ω Category 5 cable for 100Mbps, or 100Ω Category 5e/above cable for 1000Mbps connections. The cable between the switch and the link partner (switch, hub, workstation, etc.) must be less than 100 meters (328 ft.) long.
- Fiber segment using **single-mode** connector type must use 9/125 μm single-mode fiber cable. User can connect two devices in the distance

up to **30km**.

- Fiber segment using **multi-mode** connector type must use 50 or 62.5/125 μm multi-mode fiber cable. User can connect two devices up to **2km** distances.

- **Gigabit SFP port:**

The small form-factor pluggable (SFP) is a compact optical transceiver used in optical communications for both telecommunication and data communications. The SFP slots supporting Gigabit speed up to 1000Mbps. They are used for connecting to the network segment with single or multi-mode fiber. You can choose the appropriate SFP transceiver to plug into the slots. Then use proper multi-mode or single-mode fiber according to the transceiver. With fiber optic, it transmits at speed up to 1000 Mbps and you can prevent noise interference from the system.

To connect the transceiver and LC cable, please follow the steps shown below:

First, insert the transceiver into the SFP module. Notice that the triangle mark is the bottom of the module.

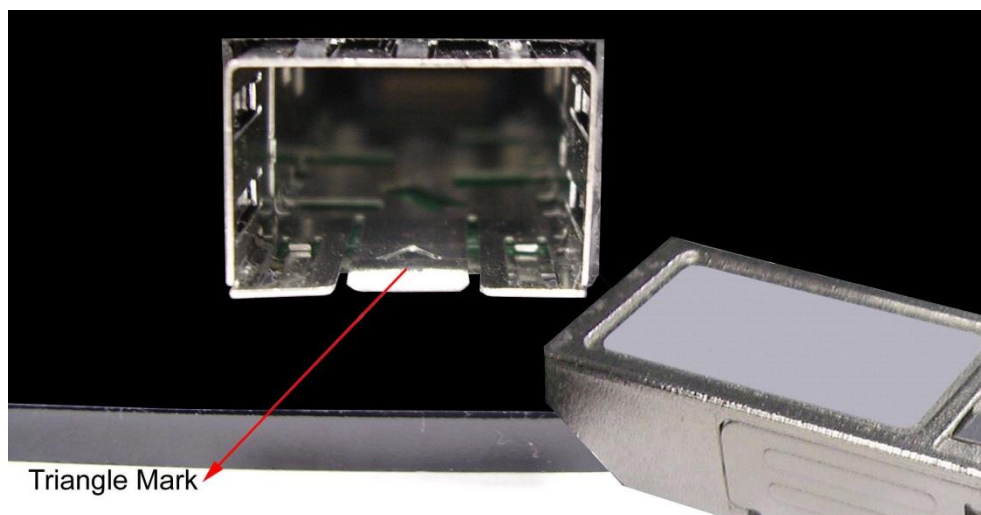

Transceiver to the SFP module

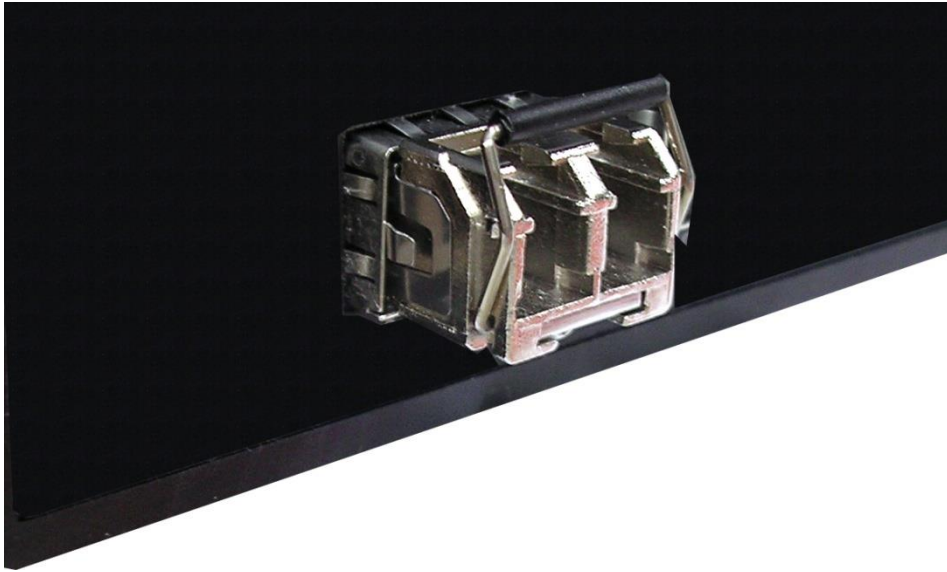

Transceiver Inserted

Second, insert the fiber cable of LC connector into the transceiver.

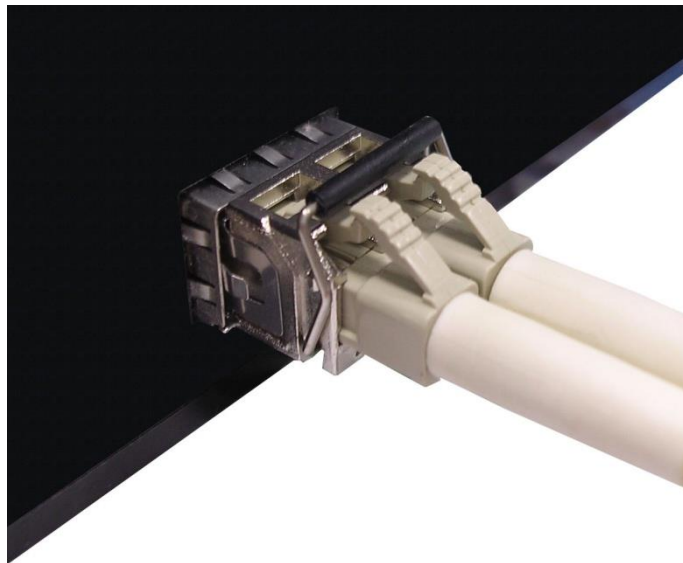

LC connector to the transceiver

To remove the LC connector from the transceiver, please follow the steps shown below:

First, press the upper side of the LC connector to release from the transceiver and pull it out.

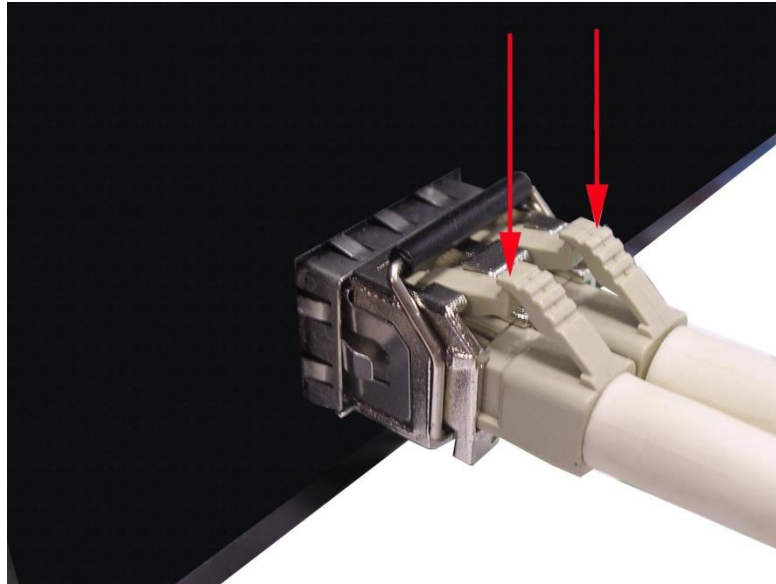

Remove LC connector

Second, push down the metal loop and pull the transceiver out by the plastic handle.

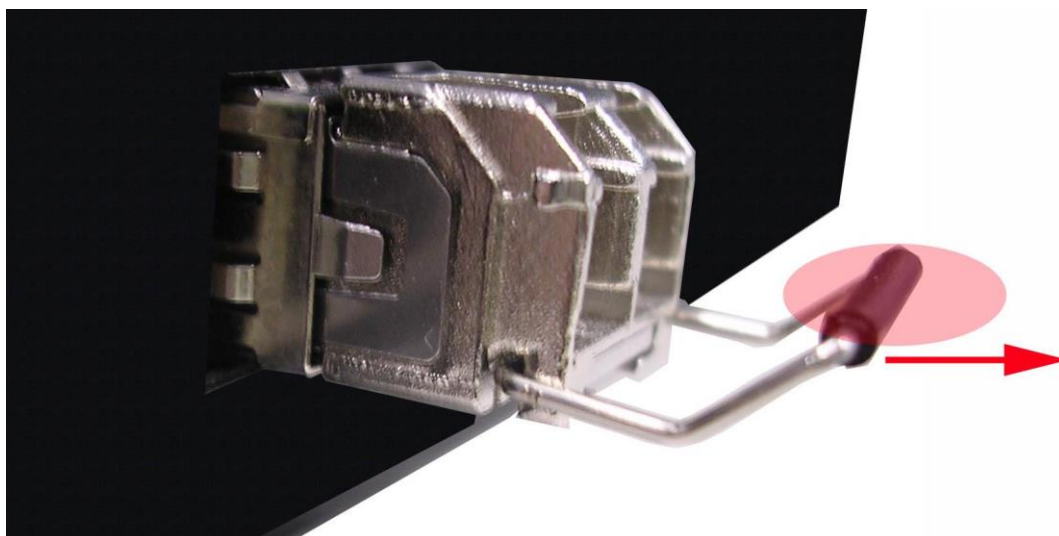

Pull out from the transceiver

Mounting Installation

DIN-Rail Mounting

The DIN-Rail is screwed on the industrial switch when out of factory. If the DIN-Rail is not screwed on the industrial switch, please see the following pictures to screw the DIN-Rail on the switch. Follow the steps below to hang the industrial switch.

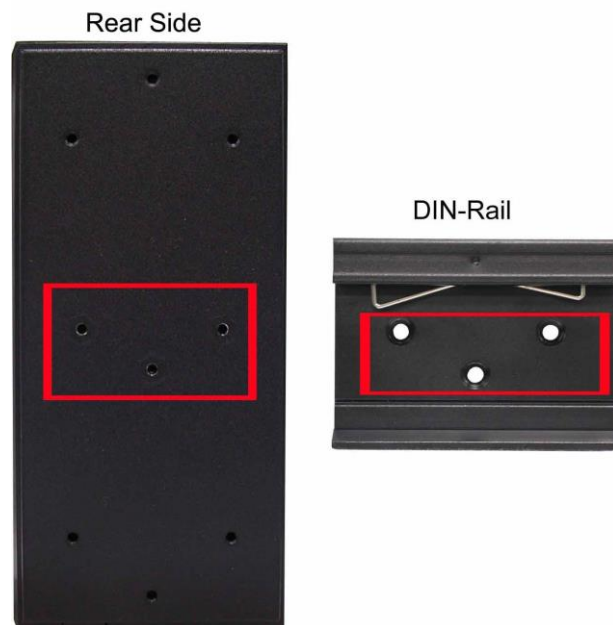

Follow the steps below to mount the industrial switch on the DIN rail:

1. Position the switch so that the upper edge and spring of the DIN clip, which is located within the top of the DIN rail bracket, engage with the top section of the DIN rail. Push down to compress the spring.

Note: Ensure a secure installation by verifying that the DIN clip's spring firmly locks into the rail groove

2. Rotate the switch to align the bottom hook of the DIN clip with the bottom section of the DIN rail and clamp it in place (refer to the image).

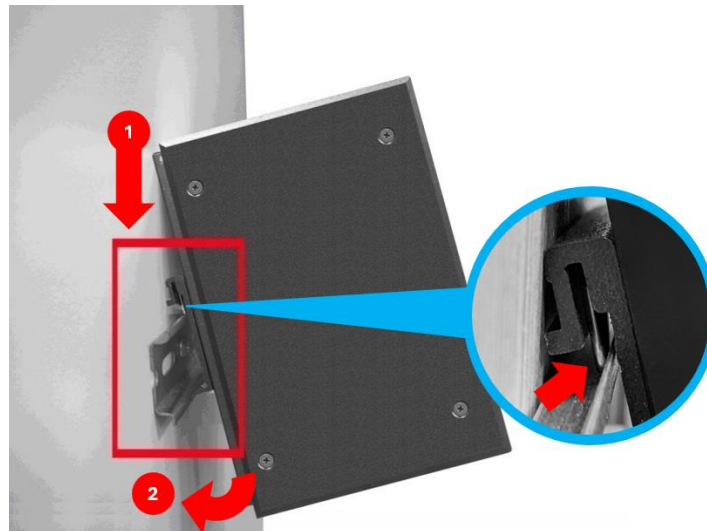

3. Verify that the DIN rail clip is securely attached to the DIN rail.

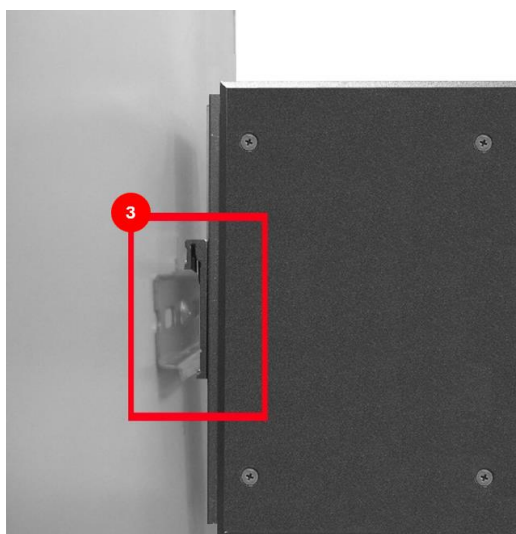

4. To remove the industrial switch, press down to compress the DIN clip spring.
5. Grasp the lower part of the switch and rotate it away from the DIN rail (refer to the image).

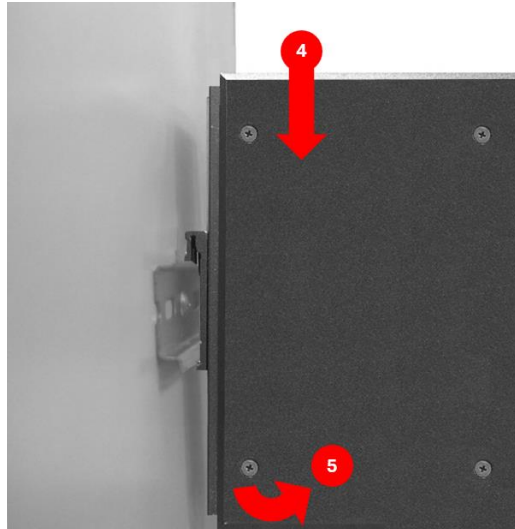

Wall-Mount Plate Mounting

***Optional Wall Mount Kit required**

Follow the steps below to mount the industrial switch with wall mount plate.

1. Remove the DIN-Rail from the industrial switch; loose the screws to remove the DIN-Rail.
2. Place the wall mount plate on the rear panel of the industrial switch.
3. Use the screws to screw the wall mount plate on the industrial switch.
4. Use the hook holes at the corners of the wall mount plate to hang the industrial switch on the wall.
5. To remove the wall mount plate, reverse the above steps.

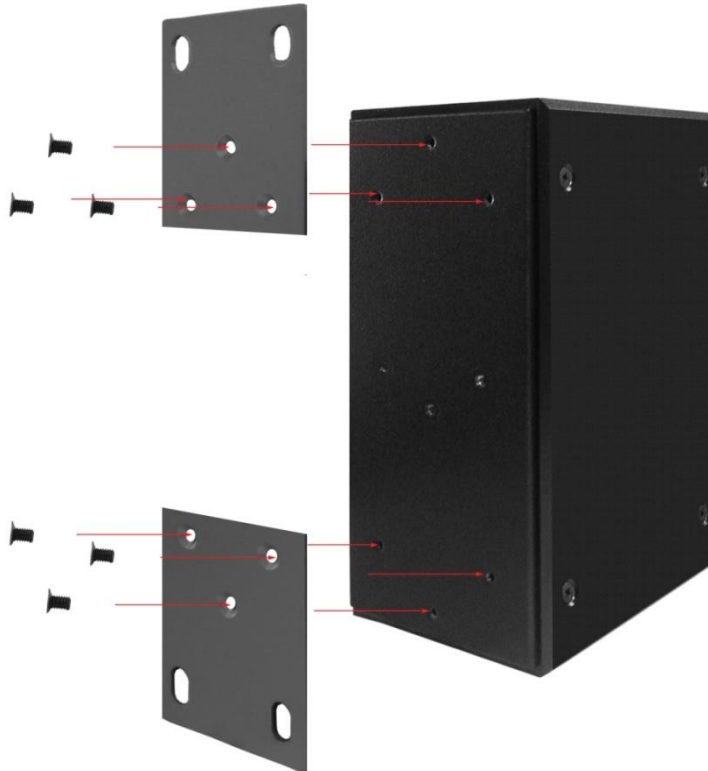
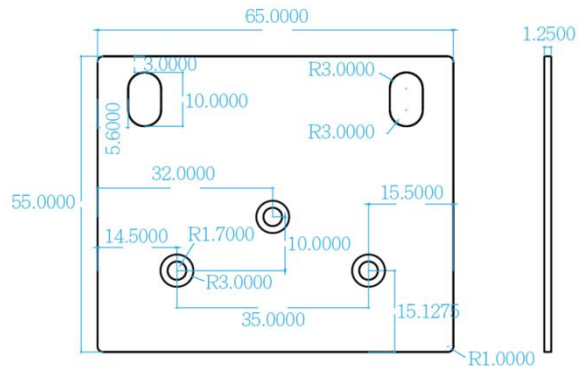

Hardware Installation

In this paragraph, we will describe how to install the 8-port 10/100/1000Base-TX Industrial Switch and the installation points for the attention.

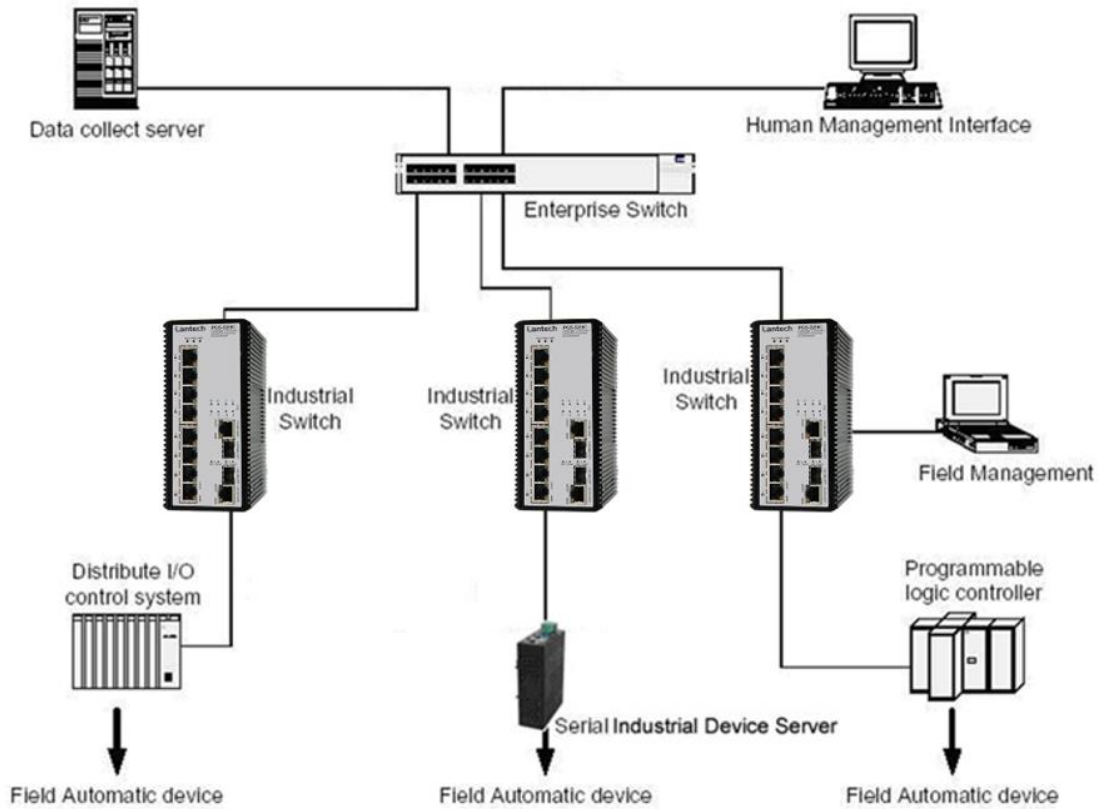

Installation Steps

1. Unpacked the Industrial switch.
2. Check the DIN-Rail is screwed on the Industrial switch. If the DIN-Rail is not screwed on the Industrial switch. Please refer to **DIN-Rail Mounting** section for DIN-Rail installation. If you want to wall mount the Industrial switch, then please refer to **Wall-Mount Plate Mounting** section for wall mount plate installation.
3. To hang the Industrial switch on the DIN-Rail track or wall, please refer to the **Mounting Installation** section.
4. Power on the Industrial switch. How to wire the power; please refer to the **Wiring the Power Inputs** section. The power LED on the Industrial switch will light up. Please refer to the **LED Indicators** section for meaning of LED lights.
5. Prepare the twisted-pair, straight through Category 5e cable for Ethernet connection.
6. Insert one side of Category 5e or above cable into the Industrial switch RJ-45 port and another side of category 5e or above cable to the network devices' RJ-45 port, ex: switch, PC or Server. The RJ-45 LED indicator on the Industrial switch will light up when the cable is connected with the network device. Please refer to the **LED Indicators** section for LED light meaning.
7. When all connections are all set and LED lights all show in normal, the installation is complete.

Troubleshooting

- Verify that you are using the included or appropriate power cord/adaptor. Don't use the power adapter with DC output higher than the power rating of the device. Otherwise, the device will burn down.
- Select the proper UTP/STP cable to construct your network. Please check that you are using the right cable. Use unshielded twisted-pair (UTP) or shielded twisted-pair (STP) cable for RJ-45 connections: 100Ω Category 3, 4 or 5 cable for 10Mbps connections, 100Ω Category 5 cable for 100Mbps, or 100Ω Category 5e/above cable for 1000Mbps connections. Also be sure that the length of any twisted-pair connection does not exceed 100 meters (328 feet).
- **Diagnosing LED Indicators:** The Switch can be easily monitored through panel indicators, which describes common problems you may encounter and where you can find possible solutions, to assist in identifying problems.
- IF the power indicator does not light on when the power cord is plugged in, you may have a problem with power cord. Then check for loose power connections, power losses or surges at power outlet. If you still cannot resolve the problem, contact your local dealer for assistance.
- If the Industrial switch LED indicators function normal and the connected cables are correct but the packets still cannot transmit, please check your system's Ethernet devices' configuration or status