

Smart workflow **x** High productivity
 Networked Storage and Computing Device

TS-x53Be

2 / 4 -bay NAS

Provides a PCIe expansion slot for multiple applications



QM2 M.2 SSD / 10 GbE network expansion card

High-performance storage system with an SSD cache or Qtier automatic tiering



Innovative accessories

Dual-port USB 3.1 Gen 2 10 Gbps Type-A Expansion Card

Lightning-fast speed, and compatible with USB 3.0 / 2.0 devices



Wireless Dual Frequency 2.4 GHz / 5 GHz PCI Express Network Expansion Card

Use the NAS as a wireless base station, and directly connect to the NAS via wireless network



Further enhancing productivity



- ◆ Quad-core Intel Celeron J3455 processor with Burst Frequency up to 2.3 GHz provides AES-NI encryption acceleration and 4K video hardware decoding and conversion.
- ◆ The QTS 4.3 operating system uses File Station as file management center, QmailAgent as a centralized email management center, Qcontactz as contacts manager, and Qsirch allows users to quickly find files.
- ◆ Supports Virtualization Station, Linux Station and Container Station to host multiple services on one device.
- ◆ Provides a magnetic cover, tool-less hard drive installation, and a system speaker with audio alerts.



TS-253Be



TS-453Be



TS-x53Be

Networked Storage and Computing Device

Compact NAS with rich functionality

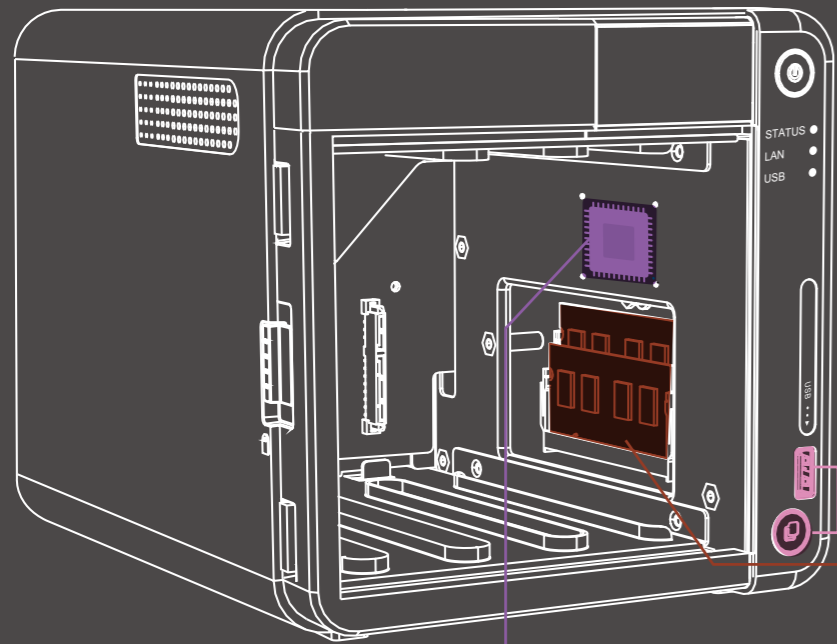

01 USB One Touch Copy

- Press the "Copy" button to quickly back up your data to/from the NAS

02 Up to 8GB DDR3L RAM

- 2 x SODIMM RAM slots

04 Intel® Celeron® J3455 Quad Core Processor 1.5 GHz, with Burst Frequency up to 2.3 GHz

- 9th generation HD Graphics graphics processor with hardware-accelerated 4K video playback and transcoding
- AES-NI encryption

03 Lockable magnetic front cover

- Dustproof and quick disassembly

Installing a PCIe card

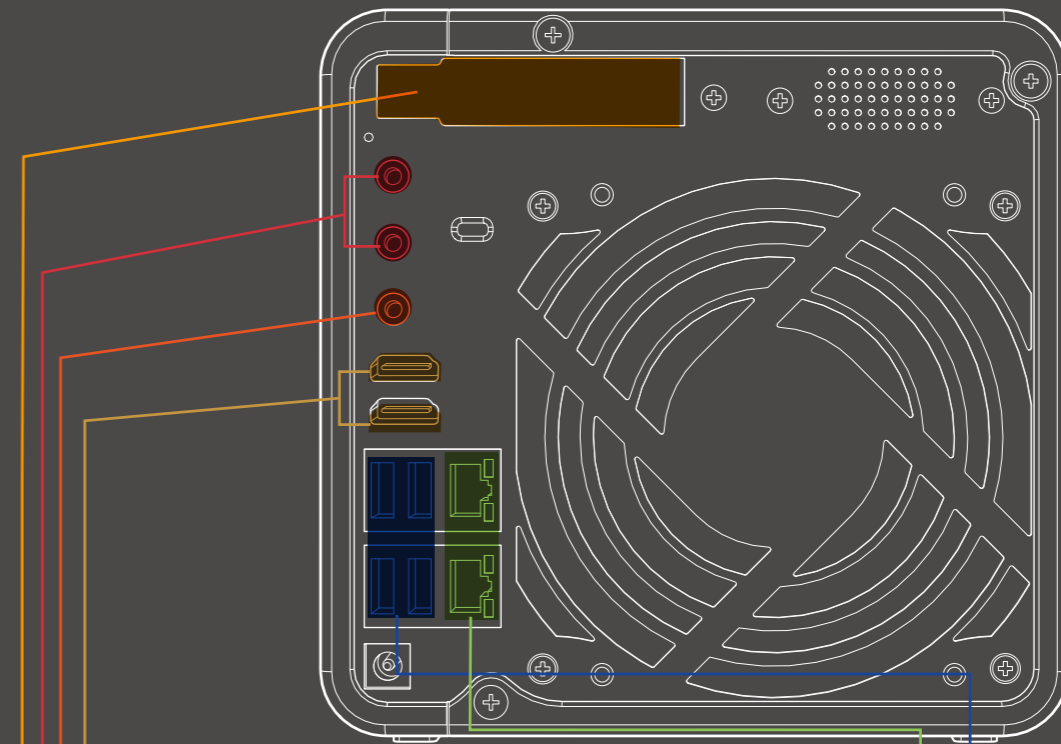
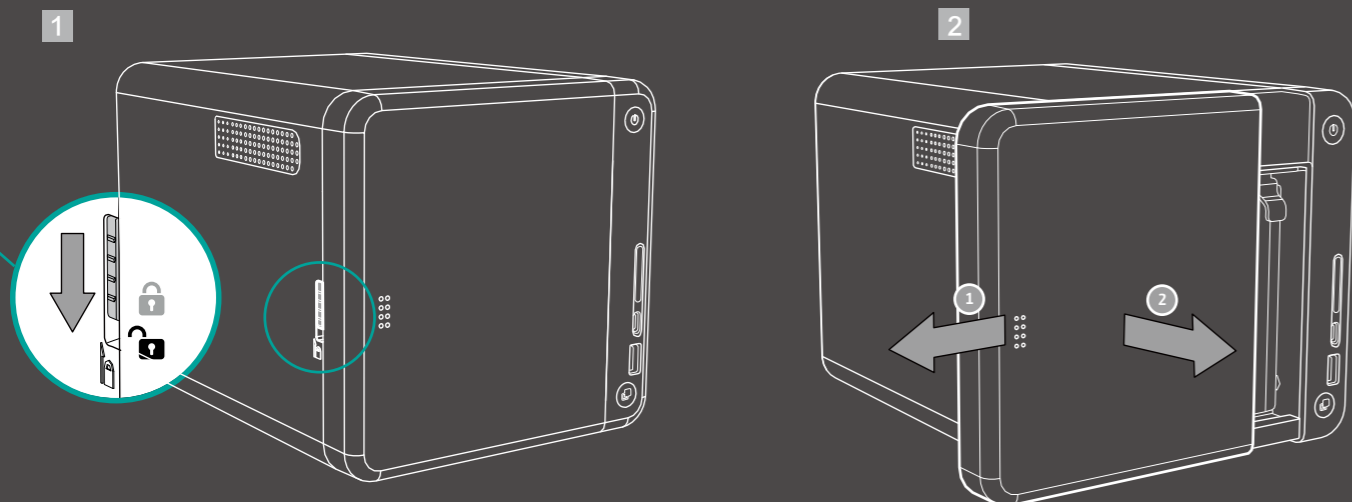

05 1 x PCIe 2.0 x 2 expansion slot

- Install a QM2 card, 10GbE network card, wireless card, or a USB 3.1 10GbE card

06 2 x 3.5 mm microphone input jacks

- Supports dynamic microphones

07 3.5 mm line out jack

- Direct audio playback

08 2 x 4K HDMI ports

- HDMI v1.4b supports up to 3840 x 2160
- Supports mirrored or extended desktop output

09 4 x USB 3.0 ports

- Supports external hard drives, printers, and UPS

10 2 x GbE ports

- Provides load balancing and other port-trunking network modes

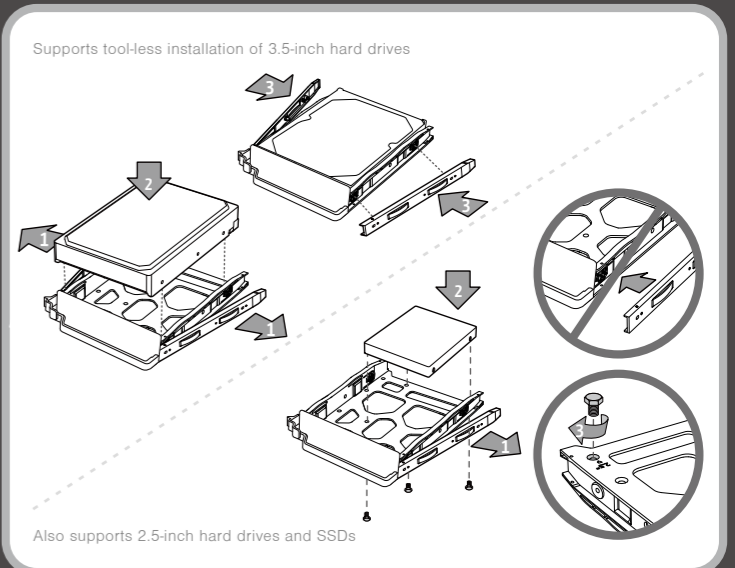

Supports tool-less installation of 3.5-inch hard drives

Also supports 2.5-inch hard drives and SSDs

Intel® Celeron® J3455 quad-core processor and AES-NI encryption

The TS-253Be/453Be is powered by an Intel® Celeron® J3455 quad-core 1.5 GHz (up to 2.3 GHz) processor and 2GB/4GB DDR3L dual-channel RAM (expandable to 8GB) with two Gigabit network ports. It supports SATA 6Gb/s and provides up to 225 MB/s continuous read/write performance for quick and smooth operation. The TS-253Be/453Be has a built-in Intel® AES-NI encryption engine using AES 256-bit encryption technology. The entire NAS or individual folders can be encrypted and still maintain up to 225 MB/s data read/write speeds, providing data confidentiality without impacting performance.

File Transfer (2 x GbE)

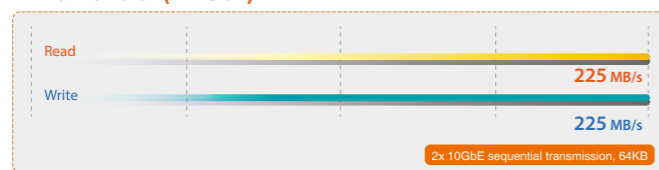

Encrypted File Transfer (2 x GbE)

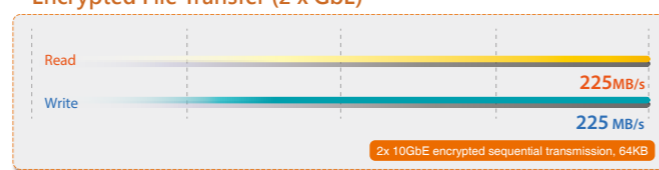

Flexible PCIe extension for multiple applications

The TS-253Be/453Be features a PCIe expansion slot to provide additional application and performance capabilities. You can install a QNAP QM2 M.2 SSD/10GbE PCIe expansion card to add a M.2 SSD cache or 10GbE connectivity to the NAS, a QNAP QWA-AC2600 wireless network card to use the NAS as a wireless network base station, or a USB 3.1 10Gbps expansion card to add additional USB ports.

Sequential transmission (2 x 10GbE, 64KB)

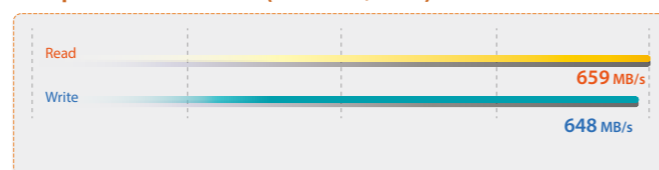

Tested in QNAP Labs. Performance may vary depending on usage environment.

Test environment:
 NAS : TS-453Be
 OS : QTS 4.3.4
 Disk group: RAID 5; 4 x Intel S3500 240GB SSDs (SSDSC2BB240G4); Equipped with QNAP LAN-10G2SF-MLX 2 ports 10GbE SFP + NIC

Client Computer:
 Intel® Core™ i7-4770 3.40GHz CPU; DDR3L 1600Hz 16GB; WD 1TB WD10EZEX; Intel Gigabit CT (MTU 1500); Windows® 10 64-bit

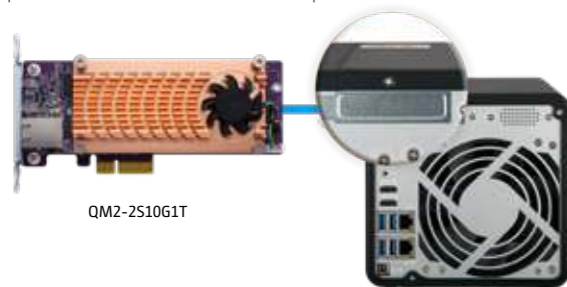

Diverse audio and video streaming

QNAP provides a wide range of multimedia apps that allow you to enjoy the photos, music, and videos stored on your NAS across all your devices. You can also directly enjoy videos stored on the TS-x53Be by connecting it to your TV's HDMI port. With 9th-generation Intel® HD Graphics with support for 2 channel (H.264) video hardware decoding playback and conversion, the TS-x53Be can transcode 4K video files to universal formats that can be smoothly played on various devices*. Media files can also be easily shared with family and friends using share links.



Qmedia can stream music, photos, and videos to a connected Android TV (Smart TV) or set-top box.



QNAP Video HD is a free KODI suite that combines KODI's powerful playback and audio format decoding capabilities with full support for Video Station functionality.

QVR Pro Surveillance Solution

QNAP's next-generation QVR Pro security monitoring solution allows you to set up an independent monitoring environment on the NAS and enjoy NAS's highly scalable storage space. Camera management, video storage planning, real-time monitoring, and video playback have become much easier. You can view surveillance footage at any time using the QVR Pro Client Mobile App, and use USB webcams as ONVIF cameras by using the QUSBCam2 app.



Protect your data with snapshots

Snapshots are an important tool for protecting NAS data. They completely record the NAS system status and data (including metadata). Use Snapshot Manager (Storage & Snapshots Manager) from the File Station to snapshot and restore data. If a file is corrupted, accidentally modified/deleted, or afflicted with malware, you can use snapshots to quickly restore file content to a previously-recorded state. QNAP snapshots are block-based and only store changed data. This not only saves space, but also significantly shortens backup and restoration time. Each volume/LUN can save up to 256 snapshots (up to a total of 1024 snapshots for the entire NAS).



Multi-point backup, multi-point access

Hybrid Backup Sync integrates data backup/restoration and synchronization functions and allows you to centrally manage backup and disaster recovery planning. Your files and data can be backed up synchronized from your NAS to another QNAP NAS, external devices, and cloud storage. With Qsync, you can quickly access NAS-based files using connected computers and mobile devices at any time.

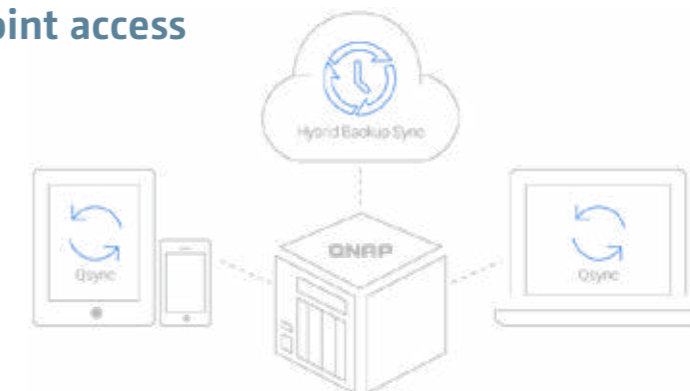

Low-cost, flexible storage expansion

With the increasing volume of data being generated every day, both home and business users should fully plan for expanding their storage capacities. QNAP provides multiple storage expansion methods to ensure that the capacity of the TS-x53Be can grow alongside your data storage requirements.

Replace with larger-capacity drives

Without shutting down the NAS, you can replace your existing hard drives with new hard drives to smoothly upgrade the NAS capacity.

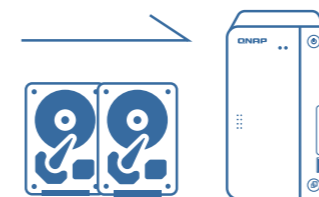

NAS system migration

Move the hard drives from your current NAS to a larger NAS. All your existing data will be retained.

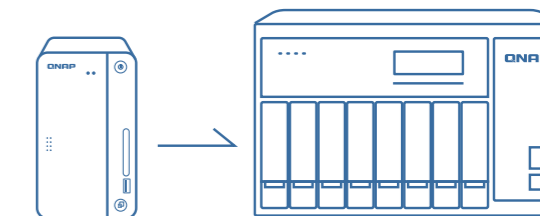

Use VJBOD

With VJBOD (Virtual JBOD) you can expand the capacity of a NAS by using the unused storage capacity of other QNAP NAS. Up to 8 remote NAS can be connected and mounted as virtual hard drives.



Expandable storage capacity

The TS-253Be/453Be can connect to a TR-004 USB 3.0 RAID expansion enclosure.

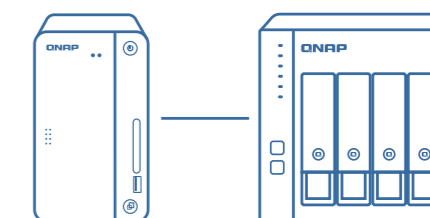

Hardware Specifications



TS-453Be



TS-253Be

NAS Model	TS-453Be-4G	TS-453Be-2G	TS-253Be-4G	TS-253Be-2G
CPU	Intel® Celeron® J3455 Quad Core 1.5 GHz, up to 2.3 GHz			
Encryption Acceleration Engine	✓ (AES-NI)			
Pictures	Intel® HD Graphics 500			
Standard system Memory	4GB DDR3L (1 x 4GB)	2GB DDR3L (1 x 2GB)	4GB DDR3L (1 x 4GB)	2GB DDR3L (1 x 2GB)
Expand up to Memory	8GB			
Memory Slots	2 x DDR3L SODIMM slot (For dual-DIMM configurations, you need to install a pair of DDR3L memories with the same speed, capacity, and chip)			
Supported Supported drive types	Hot-swappable 4 x 3.5"/2.5" SATA 6Gb/s HDD/SSD		Hot-swappable 2 x 3.5"/2.5" SATA 6Gb/s HDD/SSD	
Gigabit LAN Ports	2 x Gigabit RJ45 LAN ports			
10GbE	Optional 10 GbE PCIe network expansion card			
USB 3.0	5 x USB 3.0 Type-A ports			
PCIe slots	1 PCIe 2.0 x2 slot			
HDMI output	2 x HDMI v1.4b, up to 3840 x 2160, 30 Hz			
audio input and output	2 x 3.5mm microphone jacks, built-in speaker and 3.5mm line out jack			
LED Indicators	Status/Power, Network, USB, Hard Disk			
Button	Power/Status, USB One Touch Backup			
Infrared (IR) receiver	✓ (optional QNAP RM-IR004 remote control)			
Other slots	Kensington security lock			
Dimension (Height x Width x Depth)	168 x 170 x 226 mm 6.61 x 6.69 x 8.90 inches		168 x 105 x 226 mm 6.61 x 4.13 x 8.90 inches	
Net Weight	2.33 kg (5.14 lbs)		1.66 kg (3.66 lbs)	
Power	90W AC adapter, 100-240V		65W AC adapter, 100-240V	
Cooling	1 x 12 cm		1 x 7 cm	

Package Contents

NAS, QIG Quick Setup Guide, 2 RJ45 network cables, AC Adapter, power cable, 2.5-inch and 3.5-inch HDD installation screws

* Visit www.qnap.com for more hardware and software specifications.

Design and specifications are subject to change without notice.

Software Specifications

Supported disk group types	TS-253Be: RAID 0/1, single, JBOD; TS-453Be: RAID 0/1/5/6/10, RAID 1/5 + spare, single, JBOD
Storage & Snapshots Manager	Flexible disk area and LUN configuration. Storage pool online RAID capacity expansion and configuration migration
Supported client systems	Windows 7, Windows 8, Windows 10, Windows Server 2003/2008 R2/2012/2012R2, Apple Mac OS 10.6+, Linux & UNIX
Internal file system	EXT4
Supported external file systems	EXT4, EXT3, NTFS, HFS+, FAT32, exFAT (exFAT support requires the purchase of a license)
Supported protocols	CIFS/SMB, AFP (v3.3), NFS(v3), FTP, FTPS, SFTP, TFTP, HTTP(S), Telnet, SSH, iSCSI, SNMP, SMTP, and SMSC
File sharing	Maximum number of users: 4096; Maximum number of user groups: 512; Maximum shared folder: 512; Maximum number of simultaneous connections: 800
Video surveillance	Surveillance Station comes with 4 camera channel licenses. Additional licenses can be purchased separately (for up to 40 channels) (http://license.qnap.com)
Other Features	File Station, Photo Station, Music Station, Video Station, Download Station, Qsync, Notes Station, HD Station, FTP server, printer server, VPN server / client, Qtiier, anti-virus protection, Qsirch, Qcontactz, QmailAgent, Qfiling
Multimedia streaming	DLNA server, Airplay, Chromecast, iTunes server
Video playback and conversion	Features hardware acceleration, supports up to 4K H.264 transcoding
Remote access	myQNAPcloud

Accessories

Type	Ordering SKU	Description
Expansion Unit	TR-004	QNAP 4-bay USB 3.0 RAID enclosure
Memory	RAM-2GDR3LA0-SO-1866	2GB DDR3L 1866MHz SODIMM RAM
	RAM-4GDR3LA0-SO-1866	4GB DDR3L 1866MHz SODIMM RAM
Expansion Card	QM2-2S-220A	Supports two M.2 2280 / 22110 SATA SSDs
	QM2-2P-244A	Supports two M.2 2280 / 22110 PCIe SSDs
	QM2-2S10G1T	Supports two M.2 2280 SATA SSDs and provides a single 10GBASE-T 10 GbE network port
	QM2-2P10G1T	Supports two M.2 2280 PCIe SSDs and provides a single 10GBASE-T 10 GbE network port
	QXG-10G1T	Single-port 10GbE Multi-Gig 10GBASE-T NIC
	LAN-10G2SF-MLX	Dual-port 10GbE SFP+ NIC
	LAN-10G2T-X550	Dual-port 10GbE 10GBASE-T NIC
	QWA-AC2600	Dual-band wireless network expansion card
Remote Control	RM-IR004	Infrared remote controller (optional)

QNAP SYSTEMS, INC.

TEL : +886-2-2641-2000 FAX: +886-2-2641-0555 Email: qnapsales@qnap.com

Address : 3F, No.22, Zhongxing Rd., Xizhi Dist., New Taipei City, 221, Taiwan

QNAP may make changes to specification and product descriptions at any time, without notice.

Copyright © 2019 QNAP Systems, Inc. All rights reserved.

QNAP® and other names of QNAP Products are proprietary marks or registered trademarks of QNAP Systems, Inc.

Other products and company names mentioned herein are trademarks of their respective holders.

Netherlands (Warehouse Services)

Email: nlsales@qnap.com
TEL: +31(0)107600830

China

Email: cnsales@qnap.com
TEL: +86-400-028-0079

Thailand

Email: thsales@qnap.com
TEL: +66-2-5415988

Japan

Email: jpsales@qnap.com
FAX: 03-5901-9736

US

Email: usasales@qnap.com
TEL: +1-909-595-2782

India

Email: indiasales@qnap.com

Germany

Email: desales@qnap.com

France

Email: frsales@qnap.com



51000-024491-RS
201903 (EN) B